

**PULSE**

**Electric  
Wheelchair**



**USER MANUAL**



### After-sales service card

Dealer:			
cardholder:	contact number:	model:	
address:			Date of manufacture:
height:	weight:	Controller location:	Serial number:
<p>Quality Warranty:                      The products you buy can enjoy the following maintenance services:                      1. The motor, controller, push rod and frame have a one-year warranty; during the warranty period, free maintenance. 2. Maintenance service is provided for life, on-site maintenance requires additional on-site fee, which will be calculated separately based on the far and near costs.</p>			
Service record	Time	Content	

**Note:**

- 1: If your contact information has changed, please notify us in time!
- 2: The replaced parts belong to our company;
- 3: Batteries, tires, handrails and other vulnerable parts are not covered by the warranty.

-----  
 Packing List

Thing	Quantity
Wheelchair model	One
Charger	One
After-sales service card	One
Battery box	One
Straddle foot	Two

## Please read the manual carefully before use!

### Table of contents

- 1、Intended use ..... 1
- 2、Type, specification and structure ..... 1
  - 2.1 Product model and description ..... 1
  - 2.2 The structure of the wheelchair ..... 1
- 3、Main performance indicators ..... 1
- 4、Primary function ..... 2
- 5、Working conditions ..... 2
- 6、Installation and commissioning ..... 2
- 7、Method of use ..... 4
- 8、Battery charging ..... 5
- 9、Trouble shooting ..... 5
- 10、Routine maintenance ..... 6
- 11、Service life ..... 6
- 12、Safety precautions ..... 6
- 13、Contraindication ..... 7
- 14、Transportation and storage ..... 7
- 15、Quality Assurance instructions ..... 7
- 16、List of critical and vulnerable parts ..... 7
- 17、Electromagnetic compatibility statement ..... 8
- 18、Installation and commissioning of wheelchairs ..... 13
- 19、After Service Card ..... 17

1. Intended use

For people with disabilities or who can not walk properly(excluding obesity).

2. Type, specification and structure

(1) The product model and description are shown in the table below.

Model	Maximum user quality	Driving form	Drive wheel diameter
WT-100W	100kg	rear-wheel drive	406mm (1600 inches)
WT-100WA	100kg	front-wheel drive	406mm (1600 inches)
WT-100WB	100kg	rear-wheel drive	59mm (2200 inches)

(2)The structure of the wheelchair is shown in figure 1.

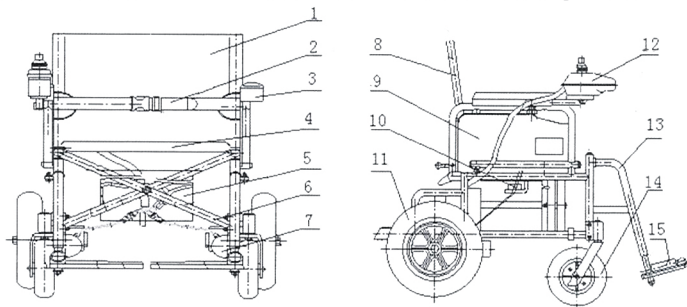

- 1 Backrest      2 Seat belts      3 Handrail      4 Seat cushion
- 5 Batteries      6 Folding frame      7 Motor      8 Chair frame
- 9 Guard plate      10 Brake      11 Rear wheel      12 Controller
- 13 Pedal frame      14 Front wheel      15 Foot pedal

Fig. 1 schematic diagram of electric wheelchair structure

3. Main performance indicators

- (1)Maximum speed:  $\leq 6$ kmh.
- (2)Running braking performance.
  - a) Horizontal Road Braking:  $\leq 1.5$  M.
  - b)Maximum Safe Slope Braking:  $\leq 3.6$  M ( $6^\circ$ ).
- (3)Slope Holding Capacity:  $9^\circ$  .
- (4)Static stability:  $\geq 9^\circ$  .
- (5)Dynamic stability:  $\geq 6^\circ$  .
- (6)Obstacle Height:  $\geq 40$  mm.
- (7)Trench width: 100 mm.

(6)Folding of the vehicle

Pull the adjustable wrench under the backrest (as shown in the picture) upwards to fold the backrest down and push forward and backward with hands (as shown in the picture) until the vehicle is completely merged. (To open the vehicle, please follow the opposite steps)



(1)



(2)



(3)

(7)Charger and battery



The charger does not provide wheelchair charging, and the charger connector is connected to the socket above the battery box (as shown in the figure).

Follow the steps below to complete the charging procedure

Step 1: Check the charger socket to make sure it is not blocked.

Step 2: Make sure that the wheelchair switch is off.

Step 3: Pull out the power plug on the controller from the battery box.

Step 4: Insert the output plug of the charger into the slot above the battery box.

Step 5: When the charger green lights up, it means that the battery has been charged.

Step 6: Pull out the output plug of the charger from the slot above the battery box.

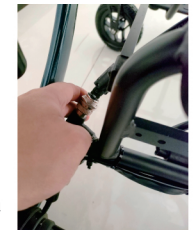

After the charger is charged, it can be connected to the battery for up to 24 hours, which can ensure that the battery is fully charged. When the charger is disconnected from the power supply, please remember to unplug the wire connected to the controller so as not to lose power. When the wheelchair is not in use, please charge it once a month to prevent the battery life from shortening.

## 18. Assembly and debugging of wheelchair

(1)The product packaging box contains a body, a battery, and a charger.

(2)Push forward and backward forcefully with both hands until the vehicle is fully opened (pictured).



(1)



(2)



(3)

(3)Insert one end of the hand control telescopic tube into the hand control fixing tube at the lower end of the armrest on the right side of the vehicle, adjust the hand control to a suitable position, and then lock the knob. Push the power cord back to a straight line. (Pictured)



(4)Hang the battery box buckle on the battery hanging rod of the vehicle, and plug in the power plug tightly. (Pictured)

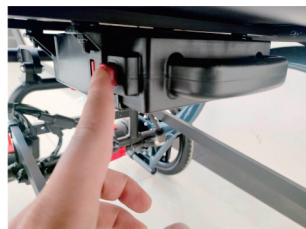

(5)Clutch style at the rear:

When the electric wheelchair fails or the battery is exhausted and cannot drive normally, it is necessary to switch the wheelchair to manual mode and push it to a safe area. The specific operations are as follows:

Move the red levers on both sides up and down, move up on both sides for electric mode, move down on both sides for manual mode.

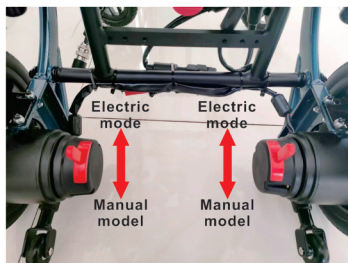

13

(8)Climbing capacity:  $\geq 6^\circ$ .

(9)Minimum turning radius: 1200 mm.

(10)Theoretical Distance:  $\geq 10$  km.

## 4. Primary function

Serial number	Function	Account for
1	Stepless speed regulation	After the programmed speed adjustment, press forward 4 gears, back 1 gears control.
2	Controller overvoltage protection	Protect the controller in case of battery overpressure.
3	Motor blocking protection	The utility model can prevent the motor from overheat and damage when the obstacle is blocked.
4	Insulation	The application part is connected with the live part, and the direct current between the two parts is $\leq 5\text{mA}$ .
5	Circuit protection	It can protect the circuit from over-current of itself and external power supply.
6	Non-insulated electrical component protection	Ensure that the user is not exposed to non-insulated parts of the motor or burned.
7	The armrest can be raised	Easy for users to get on and off.
8	The body of the chair is collapsible	Easy to transport and store.
9	Anti-rollover wheel	Prevent wheelchairs from tipping over rough roads.
10	Electromagnetic compatibility	It can be used normally in electromagnetic environment without causing electromagnetic disturbance to the environment.

## 5. Working Environment

(1)Ambient temperature:  $-10^\circ\text{C} \sim 40^\circ\text{C}$ ;

(2)Relative Humidity: 25% ~ 95% ;

(3)Internal Power Supply: DC24V.

## 6. Installation and commissioning

The Electric Wheelchair has been debugged before it leaves the factory. According to the transport requirements, part of the product factory parts used to break down packaging, so the user needs to be simple installation before use.

(1)Open the electric wheelchair packing box, you can check the contents of the packing list in the information bag.

(2)Pull the driving frame to the left and right to make the width of the vehicle normal, and press down the seat to make the left and right brackets inlaid in the recessed grooves (vehicles equipped with handle folding mechanism also need to pay attention to the coordination of their interfaces).

(3)Install the anti-rolling wheel, hold the two bumpers on the rear bracket with your hand, and insert the bracket tube obliquely upwards until the bumpers enter the corresponding holes and are fixed.

(4)Just lay it down flat. (As shown below)



02

(5) Insert the controller with the mounting bracket backwards into the square tube under the armrest, After adjusting the distance between the front and rear of the belt, tighten the screws (see Figure 3).



(6) Unscrew the screws on the outside of the battery box and read the battery connection diagram on the inner wall of the battery box cover. There are two cables in the battery box, one side is blue and black cables in the battery box, and the other side is red and black cables. There are blue and red lines on the battery.

The wiring method of the blue and black cables in the battery box is:

The blue cable is connected to the red line post, and the black cable is connected to the red line post.

The wiring method of the red and black cables in the battery box is:

The red cable is connected to the red post and the black cable is connected to the blue post.

(7) Observe the cables located in the lower part of the vehicle; if you find the cables hanging to the ground, please bundle them with the attached cable ties and keep them off the ground. Have a certain height (see Figure 4).

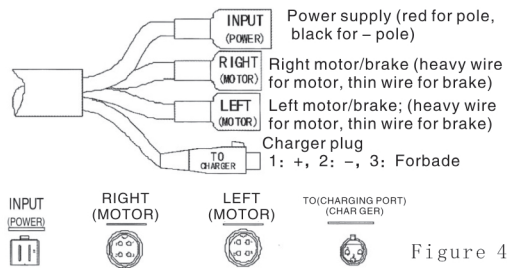

Figure 4

(8) Press the "power on button" to turn on the power of the controller, and at the same time the "battery power indicator light" and "speed grade display" lights are lit. The "battery power display" light is on to indicate that the wheelchair is powered on, the more the light is on, the more sufficient the power is; the "speed gear display" light has 5 levels, all on indicate the highest speed, the less on, the lower the speed limit (see Figure 5).

#### Controller panel

Function description:

1. Power switch button
2. Battery level display
3. Horn
4. Speed Display
5. Speed-
6. Speed+
7. Silence button
8. SOS

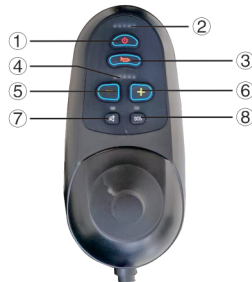

Figure 5

A bird's-eye view of the controller function keys

Table 4: Recommended isolation distances between portable and mobile radio frequency communication equipment and equipment or systems for non-life support ME equipment and ME systems

Recommended isolation distance between portable and mobile radio frequency communication equipment and KD-901E high voltage potential therapy instrument			
The electric wheelchair is expected to be used in an electromagnetic environment with controlled radio frequency radiation disturbance. According to the maximum rated output power of the communication equipment, the purchaser or user can maintain the minimum distance between the portable and mobile radio frequency communication equipment and the electric wheelchair through the following recommended To prevent electromagnetic interference.			
The maximum rated output power of the transmitter W	Corresponding to the isolation distance of the transmitter at different frequencies/m		
	150 kHz to 80 MHz $1.2\sqrt{P}$	80 kHz to 800 MHz $1.2\sqrt{P}$	800 kHz to 2.5 GHz $2.3\sqrt{P}$
0.01	0.12	0.12	0.23
0.1	0.38	0.38	0.73
1	1.2	1.2	2.3
10	3.8	3.8	7.3
100	12	12	23

For the maximum rated output power of the transmitter not listed in the above table, the recommended isolation distance d, in meters (m), can be determined by the formula in the corresponding transmitter frequency column, where p is the emission provided by the transmitter manufacturer. The maximum rated output power of the machine, in watts (w).  
 Note 1: At 80 MHz and 800 MHz frequency points, the formula for the higher frequency band is used.  
 Note 2: These guidelines may not be suitable for all situations. Electromagnetic propagation is affected by absorption and reflection from buildings, objects and humans.

(5) Functions identified as basic performance

No component damage.

Table 3: Guidelines and manufacturer's declaration-electromagnetic immunity-for non-life support ME equipment and ME systems

Guidelines and manufacturer's declaration-electromagnetic immunity			
The electric wheelchair is expected to be used in the electromagnetic environment specified below, and the purchaser or user should ensure that it is used in this electromagnetic environment.			
Immunity test	GB 9706 experimental level	Compliance level	Electromagnetic environment-guide
Conducted radio frequency GB/T 17626.6	3Vrms 150KHz~80MHz	3V	Portable and mobile radio frequency communications The device should not be longer than the recommended isolation distance stay closer to the electric wheelchair what parts are used, including cables. The distance should be due to the transmitter frequency The corresponding formula is calculated. Recommended isolation distance: d=1.2 150 kHz to 80 MHz; d=1.2 80MHz to 800MHz; d=2.3 800 MHz to 2.5GHz In the formula, p---According to the maximum rated output power of the transmitter provided by the transmitter manufacturer, in watts (w); d---Recommended isolation distance, in meters (m). The field strength of the fixed radio frequency engine is determined by surveying the electromagnetic field a, and in each frequency range b should be lower than the coincidence level. Interference may occur in the vicinity of equipment marked with the following symbols. 
Radiated radio frequency GB/T 17626.3	3V/m 80MHz~2.5Ghz	3V/m	
<p>Note 1: At 80MH and 800 MHz frequency points, the higher frequency band formula is used.</p> <p>Note 2: These guidelines may not be suitable for all situations. Electromagnetic propagation is affected by absorption and reflection from buildings, objects and humans.</p> <p>a Fixed transmitters, such as base stations of wireless (cellular/cordless) telephones and terrestrial mobile radios, amateur radios, AM and FM radio broadcasts and TV broadcasts, etc., whose field strength cannot be accurately predicted theoretically and is for evaluation For the electromagnetic environment of fixed radio frequency transmitters, electromagnetic field surveys should be considered. If the field strength of the tested equipment or system is higher than the above-mentioned radio frequency compliance level, the equipment or system should be observed to verify that it can operate normally. If abnormal performance is observed, supplementary measures may be necessary, such as reorienting or relocating the equipment or system. b In the entire frequency range of 150kHz 80MHz, the field strength should be less than 3V/m.</p>			

⑩After the power is turned on, slightly move the controller joystick in any direction, you can hear the sound of the electromagnetic clutch in the electric mechanism and the rotation of the motor. With the increase of the joystick turning range, the motor speed also increases (the sound of the motor gradually increases); turning the joystick left and right, the speed of the left and right motors (that is, the sound of the left and right motors) will change, release the joystick, the electromagnetic The clutch will release and make a sound, and the motor will stop.

⑪Close the clutch handle of the electric mechanism (make the handle parallel to the wheels), the operator sits on the car, turns on the power switch of the controller, and manipulates the car. At this time, the car moves with the direction in which the joystick of the controller is moved. The test run should be carried out in a flat place with a larger space to avoid damage to the vehicle, objects and personnel caused by the operator's unskilled manipulation of the vehicle.

⑫Press the rear tire with your hand to check whether the air pressure is sufficient; if it is insufficient, inflate it immediately. Inflation should be moderate; do not overfill to avoid puncture (the rated air pressure of inflation is 40 Pas).

### 7. Instructions

(1)For first-time users, it is recommended to drive at a low speed; to avoid accidents due to unskilled operation.

(2)For speed adjustment, there is a speed control button in front of the joystick of the controller. The operator can adjust and determine the speed according to his own situation. Press the left button (speed decrease button) to slow down, and press the right button (speed increase button) to increase speed. Stop when the joystick returns to the middle position (see Figure 6).



Figure 6

(3)When the vehicle cannot be driven by electric power due to low power or other malfunctions, the joystick can be pulled to the direction perpendicular to the wheels (the clutch is in the "off" position), and the vehicle can be pushed by hand.

(4)The armrests on both sides of the vehicle can be turned up; that is, the positioning handle at the front end of the armrest can be turned up to allow the operator to get on and off the vehicle.

#### 8. Charging batteries

(1)This product is interlocked for battery charging and power supply. When charging, unplug the battery power supply, the battery will disconnect the power supply to the control system, and insert the charger plug into the battery power supply socket for charging.

(2)A 24V, 8A fully automatic charger should be used (the charger produced by Chaowei Power Supply Co., Ltd. is recommended), and it will stop automatically when it is fully charged. If the charging indicator on the charger does not turn green after charging for more than 8 hours, it means that the battery has reached the end of its life and needs to be replaced.

(3)Try to avoid charging in direct sunlight or high temperature environments; if the battery temperature exceeds 40° C, stop charging immediately. It is best to charge the vehicle after each use. If the product is not used for a period of time, the battery should be taken out and stored separately. If it is left unused for a long time, it should be recharged once a month. It is strictly forbidden to store it under power loss.

#### 9. Troubleshooting

This product will warn the abnormal state of the vehicle through the flashing of the LED lights on the controller and the horn loop alarm sound. The first two high-frequency sounds of the acoustic signal are the guidance sound, followed by the alarm sound. According to the number and length of the alarm sound, it can be based on The following table determines the fault and eliminates it in time. The following table describes the various audible alarm states of the battery power indicator and speed/fault indicator.

Voice status	Meaning	Handling tips
All LED lights are off. Silent	The power is off or in standby or the system is in sleep mode. The power cord is in poor contact, the fuse has tripped or burned out	Check whether the power cord and fuse are connected properly
All LED lights are on.	The power is on. The product can be used normally after the power-on self-check is passed.	—
The battery indicator light is green	Indicates that the battery is sufficient.	—
The battery indicator light is yellow	Indicates that more than half of the battery is consumed	Should consider forming not too far
The battery indicator light is red	Indicates that the battery is about to run out	The battery should be charged as soon as possible
Speed/first indicator flashes	Indicates that the left motor is faulty	The left motor has poor contact or the cable is disconnected
Speed/second indicator light flashes	Indicates that the right motor is faulty	The right motor is in poor contact or the cable is disconnected
Speed/Fourth indicator flashes	Indicates that the joystick is malfunctioning	The joystick does not reset or breaks

Table 2: Guidelines and Manufacturer' s Declaration–Electromagnetic Immunity–All ME Equipment and ME Systems

Immunity test	Gb9706 test level	Coincidence level	Electromagnetic environment-guide
Electrostatic discharge GB/T 17626. 2	±6KV Contact discharge ±8KV Air discharge	±6KV Contact discharge ±8KV Air discharge	The floor should be wood, concrete or ceramic tiles. If the floor is covered with synthetic material, the relative humidity should be at least 30%
Electrical fast transient burst GB/T 17626. 4	±2KV power cord	±2KV power cord	The network power supply should be of the quality used in a typical commercial or hospital environment
Surge GB/T 17626. 5	±1KV Wire to wire ±2KV Wire to ground	±1KV Wire to wire Not applicable	The network power supply should be of the quality used in a typical commercial or hospital environment
Voltage sag, short-term interruption and voltage change on the power input line GB/T 17626. 11	<5%UT, lasting 0.5 cycle (On UT, >95% dip) 40% UT, for a 5-week period (On UT, 60% dip) 70%UT for 25 cycles (On UT, a 30% dip) <5%UT, lasting 5s (On UT, >95% dip)	<5%UT, lasting 0.5 cycle (On UT, >95% dip) 40% UT, for a 5-week period (On UT, 60% dip) 70%UT for 25 cycles (On UT, a 30% dip) <5%UT, lasting 5s (On UT, >95% dip)	The network power supply should be of the quality used in a typical commercial or hospital environment
Power frequency magnetic field (50HZ/60HZ) GB/T 17626. 8	3 A/m	3 A/m	The power frequency magnetic field should have the power frequency magnetic field level characteristics of a typical place in a typical commercial or hospital environment

Note: UT refers to the AC network voltage before the test voltage is applied

General considerations

1) Designated to be connected to the power cord of this product.

Applying the power cord provided by our company will not damage the EMC performance of this product. If an unspecified power cord is used, the EMC performance of this equipment may be significantly reduced.

2) Precautions for prohibiting user modification

The user is not allowed to modify this product, otherwise the EMC performance of this product may decrease.

The modification of the product includes the following changes:

- a) Power cord (length, material and wiring, etc.);
- b) Equipment installation/layout;
- c) Equipment configuration/components;
- d) Equipment protection parts (cover opening/closing and cover fixing parts).

3) All covers should be closed when operating the equipment. If the cover is not closed for some reason, make sure to shut down the system before starting/continuing operation.

4) When the cover is open, the operating system may affect the EMC performance of the system.

The electric wheelchair is expected to be used in the electromagnetic environment specified below, and the purchaser and user of the electric wheelchair should ensure that it is used in this electromagnetic environment.

表1

Guidelines and manufacturer's declaration electromagnetic emissions		
The electric wheelchair is expected to be used in the following electromagnetic environment. The purchaser or user of the electric wheelchair should ensure that it is used in this electromagnetic environment:		
Launch test	Coincidence	Guide to electromagnetic environment
GB 4824 RF Emission	Group 1	Electric wheelchairs use RF energy only for their internal functions. Therefore, its RF emission is very low and may not cause any interference to nearby electronic equipment.
GB 4824 RF Emission	Class B	Electric wheelchairs are suitable for use in all facilities, including households and directly connected to residential public low-voltage power supply networks for households.
GB 17625.1 Harmonic emission	Class A	
GB 17625.1 Voltage fluctuation/ scintillation emission	It fits	

10. Daily maintenance

(1) The vehicle is used in a normal temperature environment; it should not be exposed to rain to avoid short circuit.

(2) It should be wiped with a soft cloth frequently to keep the vehicle clean. If you need to clean it, wipe the surface with a neutral detergent first, then wipe it with a soft cloth dipped in clean water, and use it after drying.

(3) The controller and electric mechanism are the core components of the vehicle, so collisions and moisture should be avoided.

(4) Regularly check whether the screws and nuts on the vehicle are tightened, whether the electrical connectors are off, and whether they are too close to the ground; if you have any questions, you should promptly ask your local dealer or call the after-sales service to ensure driving safety.

(5) Note that the vehicle should be checked for sufficient power before starting each time, so as not to cause inconvenience to you when going out.

(6) Check the tire pressure frequently to ensure the normal use of the vehicle.

11. Service life

The battery life is five year.

12. Safety Precautions

(1) During operation, it is strictly forbidden to pull the clutch handle when the motor is rotating, so as to avoid serious wear of the motor components.

(2) When manipulating the controller handle, the action should be gentle, and remember to use too much force to avoid damage to the controller.

(3) It is forbidden to use wheelchair vehicles beyond the scope, such as carrying heavy objects or towing other vehicles.

(4) Do not disassemble the controller and electric mechanism at will. If there is any problem, please ask a professional for repair.

(5) When using a wheelchair, fasten your seat belt and try to keep driving at a constant speed. Do not drive on sloping roads to avoid rollover of the wheelchair.

(6) During use, do not stand on the pedals to prevent the wheelchair from tipping over and causing danger.

(7) Always check the performance of the brake to ensure its safety and reliability, and if necessary, entrust professional maintenance or adjustment.

(8) This product is limited to one person, multiple people and people whose user weight exceeds 100kg are not allowed to use it.

(9) If the wheelchair breaks down or is damaged, it must be repaired by professionals or sent back to the manufacturer for repair.

(10) Batteries that cannot be used normally after their service life should be sent back to the manufacturer for disposal, or the old batteries should be returned when buying new batteries. It is strictly forbidden to dispose of them by yourself to avoid environmental pollution.

(11) Driving on motorized lanes is prohibited.

(12) It is forbidden to modify the wheelchair without authorization.

13. Contraindications

(1) Persons with corrected visual acuity lower than 0.6 are forbidden.

(2) It is forbidden for patients with upper limb disability or behavioral disorders.

(3) Prohibited for children and pregnant women.

#### 14. Transport and storage

Electric wheelchairs should be stored in a dry, well-ventilated environment, with an ambient temperature of -20° C~+55° C, and a relative humidity of no more than 90%. The room should be protected from strong sunlight and no corrosive substances around it.

The packaged electric wheelchair can be transported by general means of transportation. During transportation, rain and snow splashes and mechanical collisions should be avoided, and no corrosive materials should be mixed.

#### 15. Quality Assurance Statement

(1) Within one year of purchasing this product, you can enjoy our company's free maintenance service.

(2) One of the following situations does not belong to the scope of free maintenance:

a) Damage caused by use not in accordance with the requirements specified in the manual, due to improper maintenance and storage.

b) Failure or damage caused by self-assembly, disassembly and repair.

c) Damage caused by other accidents or man-made.

(3) Please show the purchase certificate and warranty card before repairing. If the procedures are incomplete, our company will refuse to repair.

(4) After the product has exceeded the warranty period, our company will still provide you with free services, and only charge replacement parts when repairing.

(5) If requested by the user, the company can provide the necessary information for repairing equipment such as circuit diagrams, component lists, etc., for reference by professionals when repairing the equipment.

#### 16. List of critical and vulnerable parts

Serial number	Name	Specification	Quantity	
1	Direct current motor	24V、250W	2	
2	Controller	50A	1	
3	Accumulator	12Ah	1	
4	Fuse	0.5A	1	
5	Tire	WT-100W	406mm;254mm	Two each
		WT-100WA	406mm;254mm	Two each
		WT-100WB	559mm;254mm	Two each

#### 18. Electromagnetic compatibility statement

This product has passed the electromagnetic compatibility test and meets the requirements of the YY 0505 standard for medical equipment.

These limitations provide reasonable protection against harmful interference in a typical medical installation.

##### (1) Product composition (electrical control system)

Serial number	Part Name	Model specification
1	Direct current motor	EC82N245325A
2	Storage Battery	50A
3	Controller	50A

##### (2) Product cable

Serial number	Cable Name	Specifications	Whether to block
1	Power Cord	0.75mm <sup>2</sup>	No

##### (3) EMC performance

This equipment may be subject to radio frequency interference caused by other medical equipment and radio communications. In order to prevent such interference, this product has been tested according to YY 0505-2012 and meets its requirements. However, the company does not guarantee that there will be absolutely no interference in individual installation environments.

If the device is found to be interfered (which can be determined by turning the device on and off), the user (or qualified maintenance personnel) should try to take one or more of the following measures to solve the interference problem:

a) Adjust the direction or position that affects the equipment;

b) Increase the distance between this device and the sending device;

c) Use other power sources (rather than the power used to affect the equipment) to power the equipment;

d) Consult the supplier or service representative for other suggestions.

The manufacturer is not responsible for any interference caused by:

a) Use interconnection cables other than the recommended cables.

b) Unauthorized alteration or modification of this equipment, unauthorized alteration or modification may result in the user's right to operate this equipment in the urban area.

All types of electronic devices may cause electromagnetic interference to other devices through the air or other cables connected to them. The term EMC (Electromagnetic Compatibility) refers to the ability of a device not to be affected by electromagnetic interference generated by other devices, and at the same time not to affect other devices through similar electromagnetic radiation.

If the specified EMC performance is not fully reached, the user should install the product correctly according to the steps described in the manual. If there is a problem related to EMC, please contact the maintenance personnel.

##### (4) Precautions for product installation

1) Use the power cord provided or designated by our company. Products equipped with a power plug should be plugged into a fixed power socket with protective grounding. Do not use any type of adapter or converter (such as a "three-to-two" converter) to connect the power plug.

2) Keep this device away from other electronic devices as much as possible.

3) Make sure to use the power cord provided or specified by our company.

4) Follow the steps to connect the power cord.